

Output

Remote Sensing

To compensate the voltage drop along the power leads from the module to the load, the input of the voltage regulator is brought to terminals that are to be connected externally to the corresponding power leads at the load or - if no compensation is required - at the module. **It is important that the sense connections are not interrupted, otherwise, the output voltage may rise to the value at which the over voltage protection circuit interferes.**

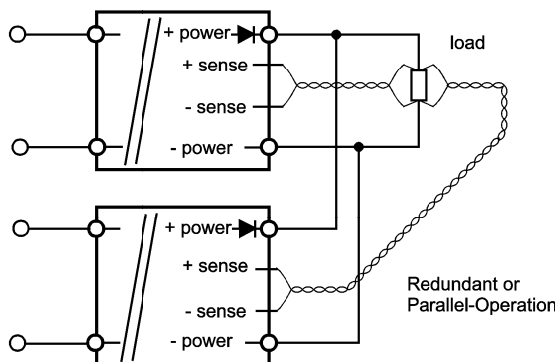
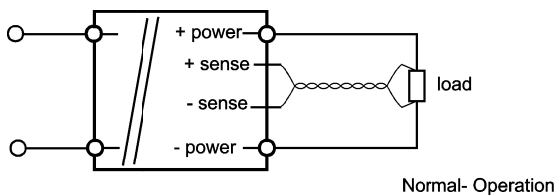

Indication of Operation

The operation of the unit is indicated by a green LED at the front connected in parallel to the output. A red LED indicates a malfunction, e.g. over voltage at the output.

Ripple

The output voltage of switch mode converters/power supplies is generated by a filter circuit from PWM regulated AC voltage.

According to the modes of filtering used, a ripple remains more or less. This ripple consists of periodic changes of the output voltage and also of the spikes generated by transistors and diodes turning on/off. It is defined and measured at the maximum input voltage/maximum output current up to 30 MHz band width.

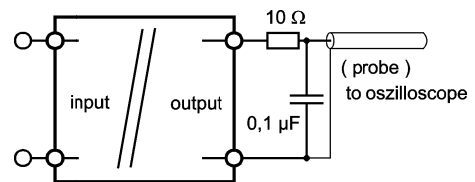

A test set-up must have the shortest possible connections to avoid or minimize pick-up and measuring faults. A small filter set-up will help (see drawing).

Even at short connections between the power supply and load, ripple and spikes may increase due to high switching currents combined with capacities / inductances of wiring / PCB's. Small capacitor blocks (1µF / 0.1µF foil capacitors) connected as near as possible to the load will solve this problem in most cases.

Over voltage Protection (OVP)

To protect the load and the internal circuits against excessive output voltage, an independent circuit switches off the primary control pulses if a certain setted output voltage is exceeded, so that no more energy is transmitted to the secondary side.

The unit automatically returns to operation with a delay of app. 0.5 sec. and switches off repeatedly if the over voltage condition continues to exist. After 5-10 sec. the unit will stay off and can be restarted by pressing the push button "RESET" or disconnecting the input.

Different from „crow-bar“ circuits, which apply a short circuit across the output terminals by firing a thyristor, the system used here **does not provide protection against over voltage that comes from outside.**

Output

No Load Operation

The primary and the secondary control circuits are powered by a small auxiliary converter operating independently from the power switching circuit. Therefore the unit operates correctly even at no load or a short at the output

Supply of Multiple Loads

Special care should be taken, that wiring is optimized, so that the losses in the wiring will not cumulate (see Drawing 1). A star-connection as shown in Drawing 2 gives a better symmetrical voltage supply to the loads. If sense lines are used, they should be connected to the load which is most sensitive to voltage fluctuations.

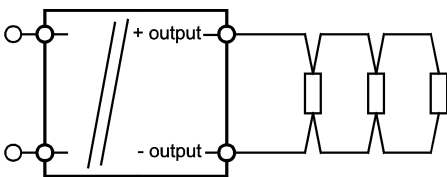

Drawing 1

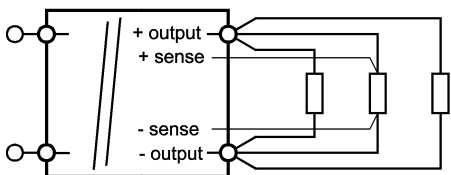

Drawing 2

Restart after Malfunction

By pressing the front panel push button "RESET" or disconnecting the input power, the unit can be restarted after an emergency shut-off due to

- over voltage at the output
- excessive currents within the switching system

Current Limiting

To protect the module and the load against excessive current, a circuitry is provided that senses the output current and takes over control when a certain level (normally 105-110%, in parallel operation 100% max. of the rated current) is exceeded. An additional circuit senses the primary current and overrides the control signal, when the primary current exceeds the normal limit. While the secondary current limiting circuit is slightly delayed to achieve dynamic stability, the primary circuit responds fast and thus protects the power transistors against current surges.

The current limit operates as a constant current source with approx. 5% accuracy. This allows the charging of all kinds of batteries.

Due to the very quick acting regulation circuitry, a tripping of the connected fuse elements only can be achieved by the energy stored within the secondary capacitors. According to the fuse characteristic / rating additional external capacitors must be added.

(Accessories CA)

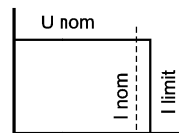
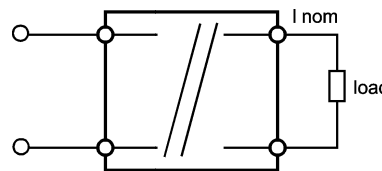

Normal-Operation

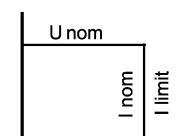
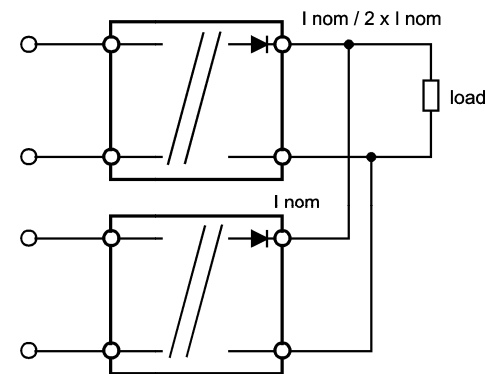

Redundant- or Parallel-Operation