

P3500/BP3500

Parallel Connection for Higher Power or Redundancy

In order to increase the output power, or for redundancy, up to 4 identical units can be connected in parallel. For this operation the output voltage should be adjusted as close as possible to each other. Typical +/-100mV difference.

For an optimal load sharing the units are provided with active current sharing. The paralleled units are interconnected with an additional Current Share Bus, consisting of two wires. The placement of these wires must be separate from the power leads, to avoid interferences. Also the length does not exceed 1m.

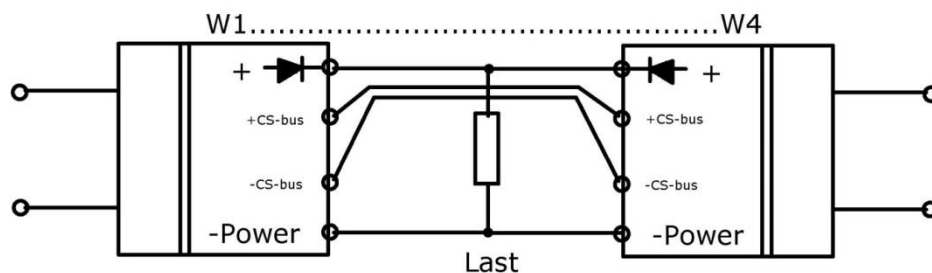

Over Voltage Protection (OVP)

To protect the load and the internal circuits against excessive output voltage, an independent circuit switches off the primary control, if a certain sated output voltage is exceeded. For a restart the input must be switch off, and after 30s a restart can be done.

Important: the system used here does not provide protection against over voltage that comes from outside.

Remote Sensing

Optional: to compensate the voltage drop along the power leads, the voltage monitoring must be done close to the load. Therefore the sense wires must be connected like in the scheme below. The placement of these wires must be separate from the power leads, to avoid interferences. The best way is to twist it.

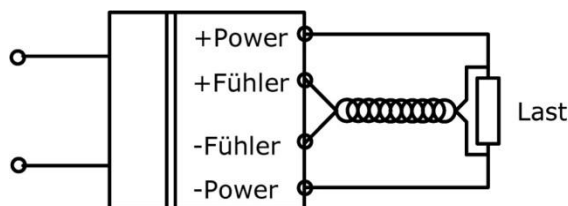

Alarm Signals and Visual Indications

If the output voltage falls below the preset value, an alarm signal is provided, thru the potential-free contacts of a Relay (NOC=open, NCC=closed). At the same time the "LED Uout" shots off.

The "LED Uin" is on, when the input supply voltage is connected. This voltage level is not defined.

In case of paralleling the units, the operation of each converter can be verified, by analyzing the output "ANODE".

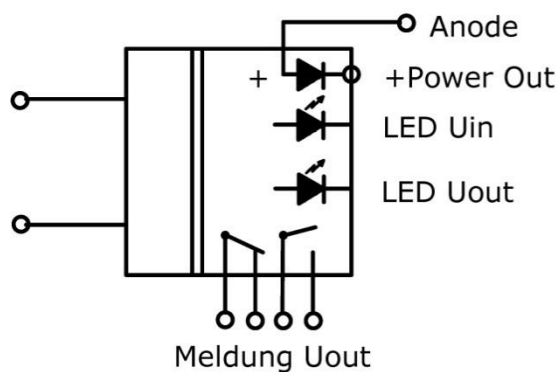

Current Boost and Overload for the P-Series

The converter disposes over a BOOST function, in order to blow up the output fuse. The current limit will be done step wise. In the first step the current limit is 4 times the nominal output current for a time of 15ms. After this time the limit will be set to nominal current level. If an overload between I-boost and I-nominal is provided, the current limit will be set to the nominal level after 15ms. In the range of I-boost and I-nominal the Boost function is inactive. By decreasing the load, under the nominal current level, the Boost function is again active.

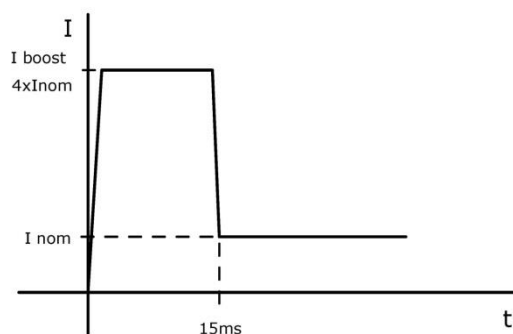

Charge Voltage depending on ambient temperature (just for BP-Series)

For the BP-Series it is possible to adjust the charge voltage, depending on ambient temperature. A NTC resistor has to be mount in the sense line circuit, like in the scheme below. The position of NTC must be near to the battery.

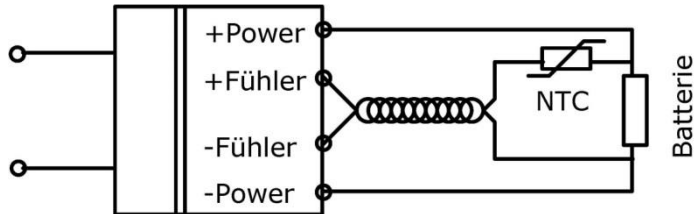

Boost Charge (just for BP-Series)

For the BP-Series the setting of the charge voltage can be done with an external remote control voltage. This input is potential free, and is controlled by an optocoupler. The function can be used for boost charge, or trickle charge.

